

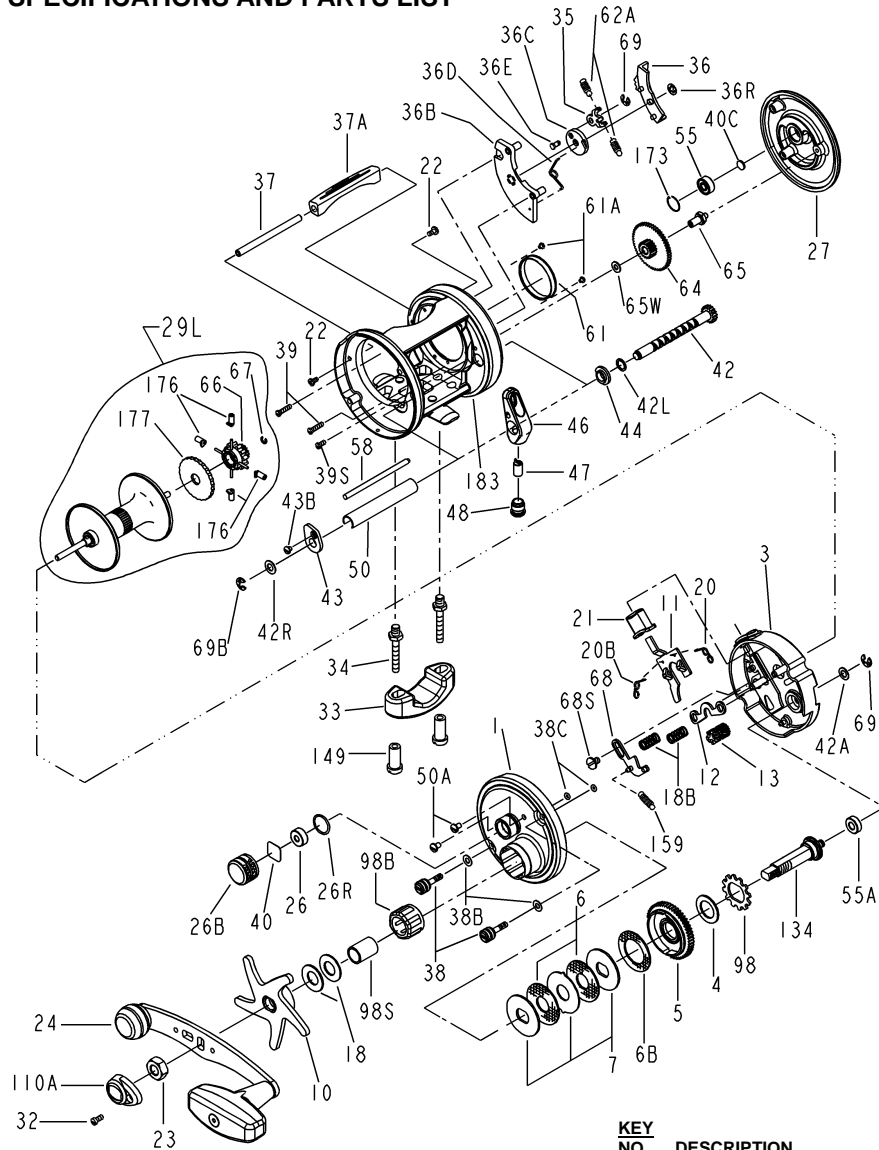

# INTERNATIONAL 975 SPECIFICATIONS AND PARTS LIST

Congratulations on the purchase of your new Penn International® baitcaster! For general features, operating instructions, casting control information, maintenance, lubrication and servicing, please refer to the main International® manual (featuring the 965). Keep this sheet for reference to 975 part numbers and specifications. Good fishing!



LINE CAPACITY	GEAR RATIO	WEIGHT
340 YDS / 15 LBS	4.5:1	15 OZ
310 METERS / 0.40 MM		425 GRAMS

KEY NO.	DESCRIPTION	PART NO.
1	Right Side Plate	001 975
3	Inner R.S. Plate	003 975
4	Fibre Washer	004 155
5	Main Gear	005 975
6	Drag Washer HT-100 (2 req.)	006 309
6B	Drag Washer HT-100	006B965
7	Metal Drag Washer (Set of 3)	007C965
10	Star Drag	010 975
11	Eccentric Jack	011 975
12	Yoke	012 965
13	Pinion	013 975
18	Disc Clutch Spring (2 req.)	018 975

KEY NO.	DESCRIPTION	PART NO.
18B	Yoke Spring (2 req.)	018B965
20	R.S. Jack Spring	020 965
20B	L.S. Jack Spring	020B965
21	Clutch Release Button	021 975
22	Post Screw (2 req.)	050 716
23	Handle Nut	023 555
24	Handle Assembly	024 555
26	Spool Bushing	026 965
26B	Spool Tension Cap	026B965
26R	Tension Cap 'O' Ring	026R965
27	Left Side Plate	027 975
29L	Spool Assembly	029L975
32	Handle Cap Screw	032 015
33	Rod Clamp	033 113
34	Rod Clamp Screw (2 req.)	034 975
35	Click Tongue	035 965
36	Click Button	036 975
36B	Click Housing	036B975
36C	Click Wheel	036C965
36E	Click Tongue Pin	036E965
36D	Click Wheel Spring	036D965
36R	Retaining Ring	036R965
37	Thumb Bar Post	037 975
37A	Thumb Bar	037A975
38	Take-Apart Screw (2 req.)	038N965
38B	Side Plate Washer (2 req.)	038BN965
38C	Screw 'O' Ring (2 req.)	038CN965
39	L.S. Plate Screw (2 req.)	039 965
39S	L.S. Plate Short Screw	039S965
40	Metal Thrust Washer	040C965
40C	Metal Thrust Washer	040C310
42	Worm Shaft	042 975
42A	Metal Washer	042R965
42L	L.S. Worm Shaft Washer	042L965
42R	R.S. Worm Shaft Washer	042R965
43	R.S. Worm Shaft Bushing	043 965
43B	Worm Bushing Screw	043B965
44	L.S. Worm Shaft Bushing	044 975
46	Line Guide	046 975
47	Pawl	047 975
48	Pawl Cover Screw	048 965
50	Worm Shield	050 975
50A	R.S. Plate Screw (2 req.)	050 716
55	Ball Bearing	055 113H
55A	Gear Stud Bushing	055A965
58	Line Guide Post	058 975
61	Brake Drum	061 965
61A	Brake Drum Screw (2 req.)	043B965
62A	Click Spring (2 req.)	062A965
64	Idler Gear	064 975
65	Idler Gear Pin	065 965
65W	Idler Gear Washer	065W965
66	Spool Gear Click Ratchet	066M965
67	Lock Ring	067 016S
68	Shift Arm	068 965
68S	Shift Arm Screw	068S965
69	Retaining Ring	069B050
69B	Retaining Ring (2 req.)	069B600
98	Trip Ratchet	098 965
98B	Roller Bearing	098B525
98S	Bearing Clutch Shaft	098S525
110A	Handle Nut Cap	110A555
134	Gear Stud	134 975
149	Rod Clamp Nut (2 req.)	149 045
159	Shift Arm Spring	159 965
173	L.S. Bearing Retainer	173 965
176	Anti-Backlash Brakes (4 req.)	176 965
177	Brake Selection Knob	177 965
183	Frame Assembly	183 975