

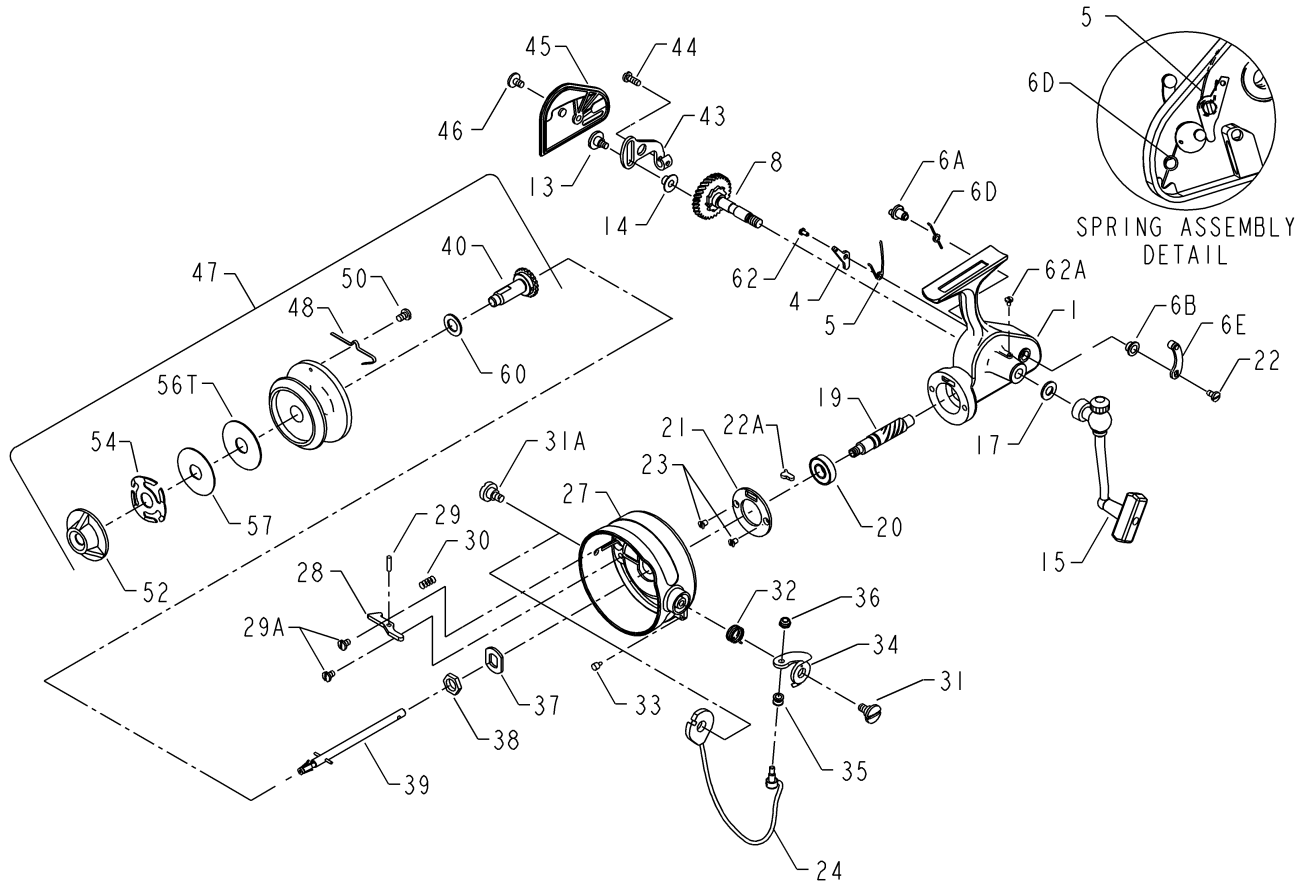

PARTS LIST FOR MODEL 716Z



KEY NO.

KEY NO.	DESCRIPTION	PART NO.
1	Housing w/Bushing	001 716Z
4	Dog	004 716
5	Dog Spring	005 716
6A	Eccentric	006A716
6B	Eccentric Liner	006B700Z
6D	Eccentric Spring	006D716
6E	Eccentric Lever	006E716
8	Main Gear w/Ratchet and Shaft	008 716
13	Crosswind Screw	013 716
14	Crosswind Roller	014 716
15	Handle Assembly (Complete)	015 716Z
17	Handle Washer	017 716
19	Pinion Gear	019 716
20	Pinion Bearing	020 722
21	Bearing Retainer	021 716
22	Eccentric Screw	022 109
22A	Bail Release Ramp	022 716
23	Bearing Retainer Screw (2 req.)	023 716
24	Bail Wire Assembly	024 716
27	Rotor Cup	027 716Z
28	Bail Release Arm	028 716
29	Release Arm Pin	029 716
29A	Release Arm Screw (2 req.)	029A716
30	Arm Release Spring	030 716
31	Bail Arm Screw	031 716
31A	Bail Screw	031A716
32	Bail Spring	032 716
33	Bail Arm Bumper	033R712
34	Abail Arm	034 716
35	Line Roller	035 716
36	Bail Lock Nut	036 700
37	Rotor Cup Washer	037 716
38	Rotor Cup Nut	038 720
39	Spool Shaft Assembly	039 716
40	Spool Sleeve	040 716
43	Crosswind Arm	043 716
44	Crosswind Shaft Screw	044 716
45	Housing Plate	045 714Z
46	Housing Plate Screw	046 716
47	Spool Assembly (Complete)	047 716Z
48	Click Spring	048 716
50	Release Arm Screw (2 req.)	050 716
52	Drag Knob	052 716Z
54	Drag Spring	054 716
56T	Drag Washer (Teflon®)	056T716
57	Metal Keyed Washer	057 716
60	Rear Drag Washer	060 716
62	Dog Screw	062A716
62A	Oiler Screw	062A716